



ASI-T-430FA2F6/AY

ITEM	Standard value	UNIT
LCD Type	IPS TFT Transmissive	---
Driver element	Active matrix	
Number of Dots	480*(RGB)*272	Dots
Pixel Arrangement	RGB Vertical Stripe	
Dot Pitch (W*H)	0.198*0.198	mm
Active Area	95.04(H)*53.86(V)	mm
Viewing Area (W*H)	****(H)*****(V)	mm
Glass Area (W*H)	100.16*61.86	mm
Viewing Direction	ALL FREE	
Control IC	SC7283	
Module Size(W*H*T)	105.42*67.07*3.0	mm
Approx. Weight	TBD	g
Back Light	7 White LED	
Touch Panel Type	G+F+F(GT911)	
Touch Panel Active Area	96.7*55.5	mm
TP+LCM Size(W*H*T)	105.42*67.07*4.55	mm



Contents

1	Introduction-----	4
2	General specification-----	5
3	Mechanical drawing-----	6
4	Absolute maximum ratings-----	7
5	Electrical characteristics-----	7
6	Optical characteristics -----	8
7	Pin Assignment -----	10
8	AC Characteristics.-----	11
9	LCM quality criteria-----	14
10	Reliability Test Items-----	19
11	Packing and Storage -----	20
12	Suggestions for using -----	24

1. Introduction

1.1 Scope of application

This specification applies to the a- TFT transmissive dot matrix LCD module. This LCD module should be designed for mobile machine application. LCD specification: Dots 480xRGBx272. As to basic specification of the driver IC, refer to the IC (SC7283) datasheet.

1.2 Structure:

Display structure:
CTP+TFT LCD+IC+FPC+BL
FULL 16.7M Colors 4.3 inch TFT LCD size for LCD;
One bare chip with gold bump (COG) TECH;
White LED back light;
24BIT RGB

1.3 TFT features:

TFT PANNEL+IC+FPC;
IPS Tran missive Type LCD
480 dot-source and 272 dot-gate outputs;

1.4 Applications:

Mobile machine

2. General specification

ITEM	Standard value	UNIT
LCD Type	IPS TFT Transmissive	---
Driver element	Active matrix	
Number of Dots	480*(RGB)*272	Dots
Pixel Arrangement	RGB Vertical Stripe	
Dot Pitch (W*H)	0.198*0.198	mm
Active Area	95.04(H)*53.86(V)	mm
Viewing Area (W*H)	****(H)*****(V)	mm
Glass Area (W*H)	100.16*61.86	mm
Viewing Direction	ALL FREE	
Control IC	SC7283	
Module Size(W*H*T)	105.42*67.07*3.0	mm
Approx. Weight	TBD	g
Back Light	7 White LED	
Touch Panel Type	G+F+F(GT911)	
Touch Panel Active Area	96.7*55.5	mm
TP+LCM Size(W*H*T)	105.42*67.07*4.55	mm

3. Mechanical drawing

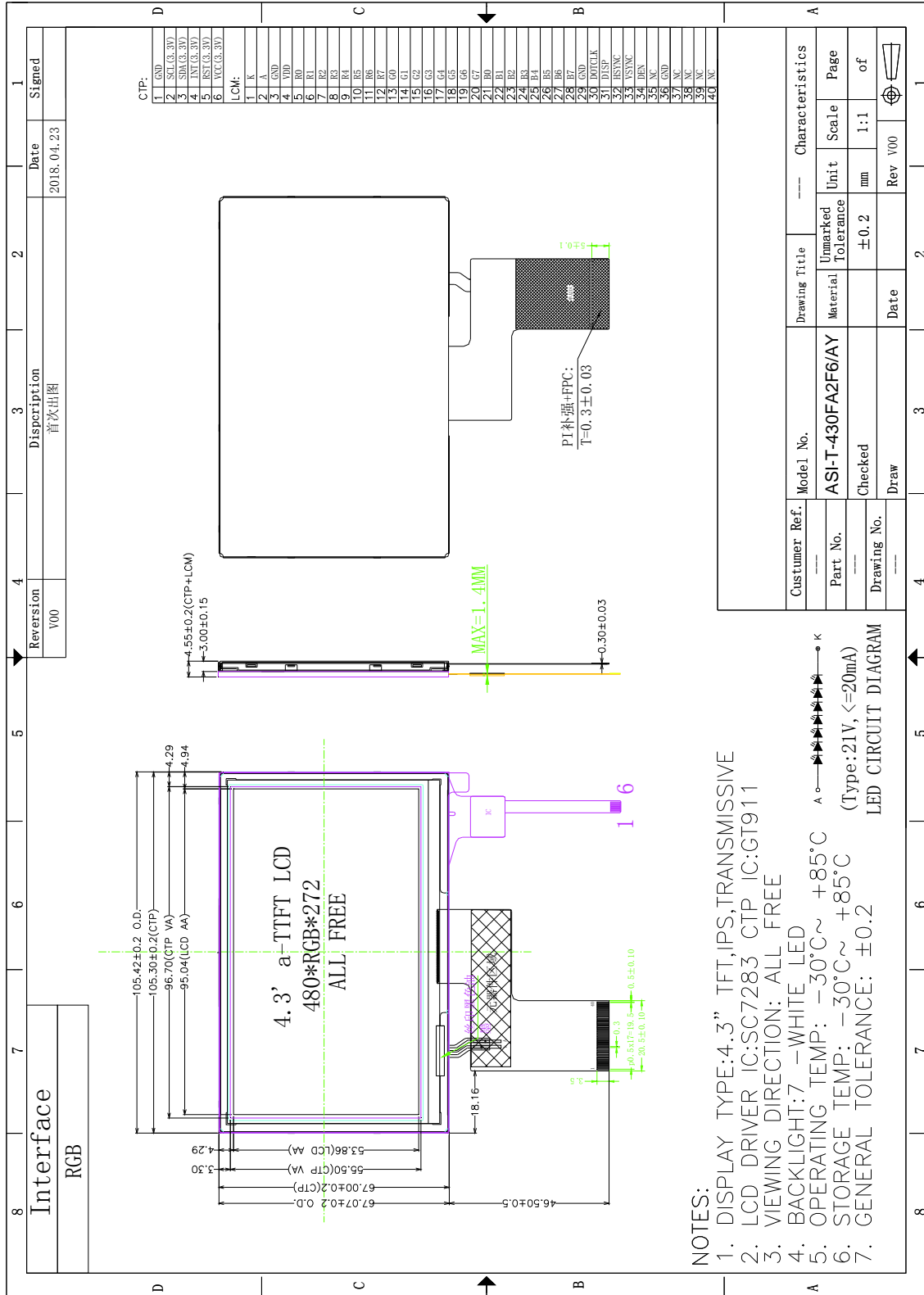

4. ABSOLUTE MAXIMUM RATINGS

Parameter	Symbol	Min	Max	Unit
Supply voltage for logic	V_{DD}	-0.3	4.6	V
Input voltage for logic	V_{IN}	-0.5	$V_{DD} + 0.3$	V
Supply current (One LED)	I_{LED}	0	20	mA
Operating temperature	T_{OP}	-30	+85	°C
Storage temperature	T_{ST}	-30	+85	°C

5. ELECTRICAL CHARACTERISTICS

Item	Symbol	Min	Typ	Max	Unit	Applicable terminal
Supply voltage for logic	V_{DD}	3.0	3.3	3.6	V	V_{DD}
Supply voltage for analogy	V_{CC}	3.0	3.3	3.6	V	V_{DD}
Input voltage	V_{IL}	-	-	$0.2 V_{DD}$	V	
	V_{IH}	$0.8 V_{DD}$	-	V_{DD}	V	
Input current	I_{DD}	-	25	-	mA	
LED Forward voltage	V_f	19.6	21	23.1	V	7LED
Input backlight current	I_{LED}	-	15	20	mA	
Brightness(Backlight)	L	-	3000	-	Cd/m^2	$I_{LED}=20mA$

6. OPTICAL CHARACTERISTICS

ITEM	SYMBOL	CONDITIONS	SPECIFICATIONS			UNIT	NOTE	
			MIN.	TYP.	MAX			
Brightness	B	Viewing normal angle	--	220	--	Cd/m ²		
Contrast Ratio	CR		--	800	--	--		
Response Time	Tr+Tf		--	30	40	ms		
CIE Color coordinate	Red		X _R	--	0.654	--		
			Y _R	--	0.319	--		
	Green		X _G	--	0.259	--		
			Y _G	--	0.574	--		
	Blue		X _B	--	0.140	--		
			Y _B	--	0.084	--		
White	X _w		--	0.303	--			
	Y _w	--	0.323	--				
Viewing Angle	Hor.	θ_{x+}	--	80	--	Deg.		
		θ_{x-}	--	80	--			
	Ver.	θ_{y+}	--	80	--			
		θ_{y-}	--	80	--			
Uniformity	Un		--	TBD	--	%		

Note 1 : Definition of Viewing Angle θ_x and θ_y :

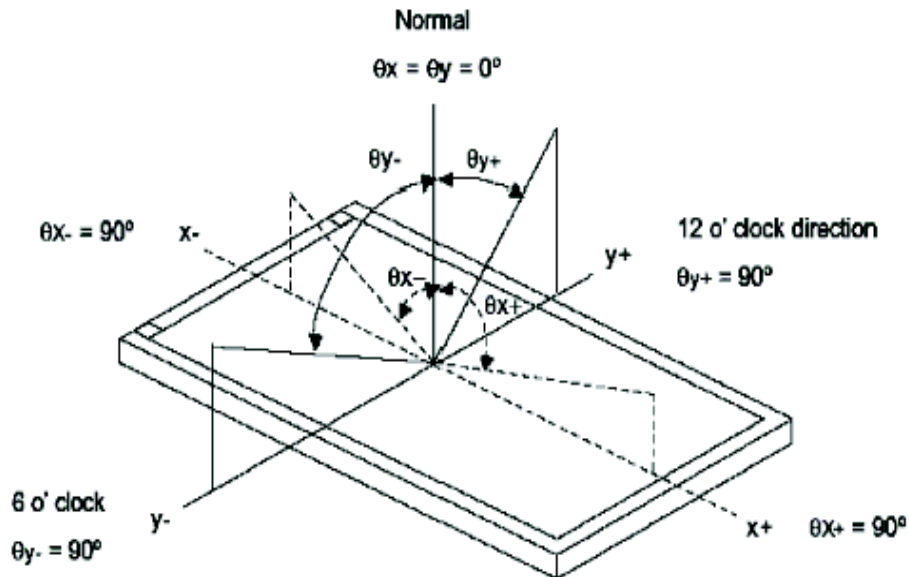

Note 2: Definition of contrast ratio CR:

$$CR = \frac{\text{Brightness of non-selected dots (white)}}{\text{Brightness of selected dots (black)}}$$

Note 3: Definition of response time (T_R, T_F)

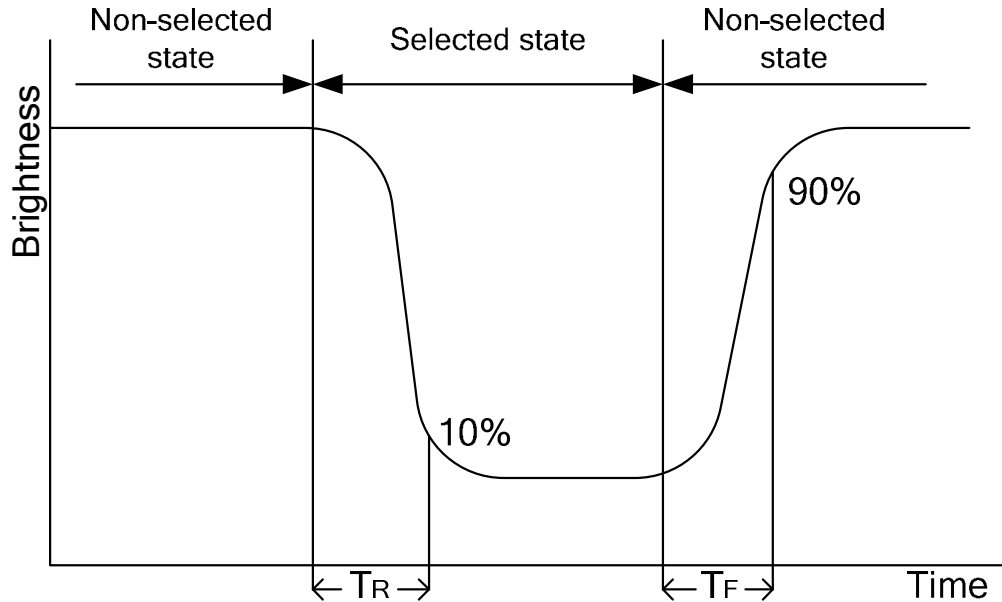

Note 4: Measuring method for luminance, luminance uniformity.

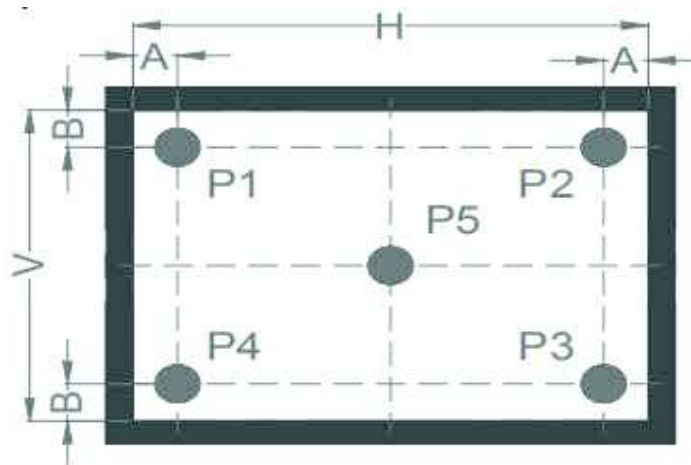

A:5mm /B: 5mm/H,V: active area/Light spot size= Φ 5mm
500mm distance from LCD surface to detector lens of the BM-7

7. Interface Pin Function

NO.	SYMBOL	Description
LCM:		
1	LEDK	Backlight power(-)
2	LEDA	Backlight power(+)
3	GND	Power ground
4	VDD	Power supply(+3.3V)
5-12	R0-R7	The red data of 24bit RGB interface
13-20	G0-G7	The green data of 24bit RGB interface
21-28	B0-B7	The blue data of 24bit RGB interface
29	GND	Power ground
30	DCLK	The dot clock of the RGB interface
31	DISP	The display off signal active Low level
32	HSYNC	The horizontal sync signal of the RGB interface
33	VSYNC	The vertical sync signal of the RGB interface
34	DEN	The data input enable signal
35	NC	No use
36	GND	Power ground
37-40	NC	No use
CTP:		
1	GND	Power ground
2	SCL	The clock line of the IIC interface
3	SDA	The data line of the IIC interface
4	INT	The touch signal output
5	RST	The reset signal for CTP IC.
6	VCC	Power supply(+3.3V)

8. AC Characteristics

Please refer the IC SC7283 (LCD) and GT911 (CTP) datasheet

9.LCM Quality Criteria

9.1 VISUAL & FUNCTION INSPECTION STANDARD

9.1.1 Inspection conditions

Inspection performed under the following conditions is recommended.

Temperature : 25±5°C

Humidity : 65%±10%RH

Viewing Angle : Normal viewing Angle.

Illumination: Single fluorescent lamp (300 to 700Lux)

Viewing distance:30-50cm

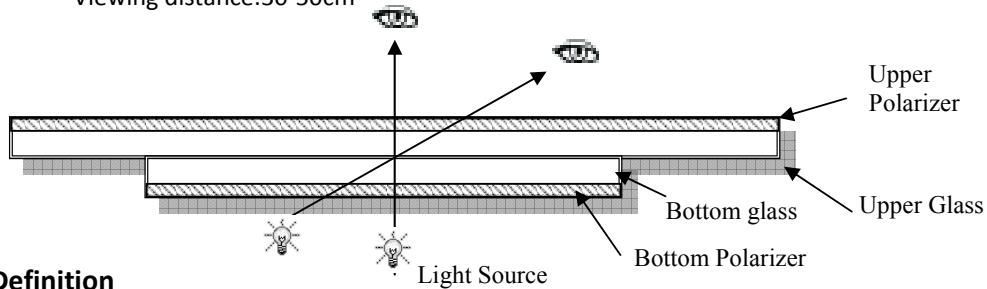

9.1.2 Definition

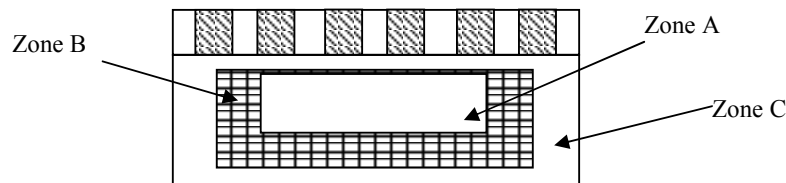

Zone A : Effective Viewing Area(Character or Digit can be seen)

Zone B : Viewing Area except Zone A

Zone C : Outside (Zone A+Zone B) which can not be seen after assembly by customer .)

Note:

As a general rule ,visual defects in Zone C can be ignored when it doesn't effect product function or appearance after assembly by customer.

9.1.3 Sampling Plan

According to GB/T 2828-2003 ; , normal inspection, Class II

AQL:

Major defect	Minor defect
0.65	1.5

LCD: Liquid Crystal Display , TP: Touch Panel , LCM: Liquid Crystal Module

No	Items to be inspected	Criteria	Classification of defects
1	Functional defects	1) No display, Open or miss line 2) Display abnormally, Short 3) Backlight no lighting, abnormal lighting. 4) TP no function	Major
2	Missing	Missing component	
3	Outline dimension	Overall outline dimension beyond the drawing is not allowed	
4	Color tone	Color unevenness, refer to limited sample	Minor
5	Soldering appearance	Good soldering , Peeling off is not allowed.	
6	LCD/Polarizer/TP	Black/White spot/line, scratch, crack, etc.	

9.1.4 Criteria (Functional items)

Number	Items	Criteria (mm)
1	No display	Not allowed
2	Missing segment	Not allowed
3	Short	Not allowed
4	Backlight no lighting	Not allowed
5	TP no function	Not allowed

9.1.5 Criteria (Visual)

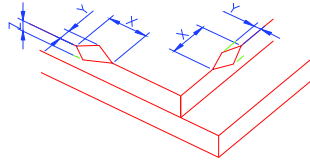
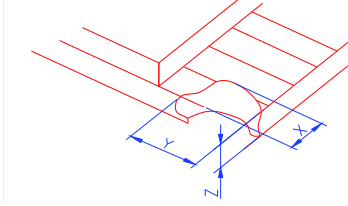
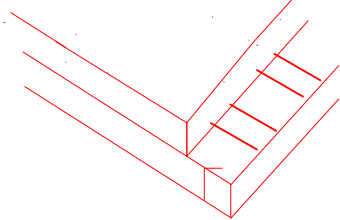
Number	Items	Criteria(mm)						
1.0 LCD Crack/Broken NOTE: X: Length Y: Width Z: Height L: Length of ITO, T: Height of LCD	(1) The edge of LCD broken	 <table border="1" data-bbox="857 758 1365 905"> <thead> <tr> <th>X</th> <th>Y</th> <th>Z</th> </tr> </thead> <tbody> <tr> <td>≤3.0mm</td> <td><Inner border line of the seal</td> <td>≤T</td> </tr> </tbody> </table>	X	Y	Z	≤3.0mm	<Inner border line of the seal	≤T
	X	Y	Z					
	≤3.0mm	<Inner border line of the seal	≤T					
(2)LCD corner broken	 <table border="1" data-bbox="915 1146 1308 1213"> <thead> <tr> <th>X</th> <th>Y</th> <th>Z</th> </tr> </thead> <tbody> <tr> <td>≤3.0mm</td> <td>≤L</td> <td>≤T</td> </tr> </tbody> </table>	X	Y	Z	≤3.0mm	≤L	≤T	
X	Y	Z						
≤3.0mm	≤L	≤T						
(3) LCD crack	 <p>Crack Not allowed</p>							

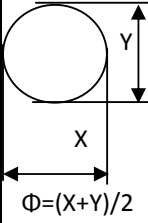
Number	Items	Criteria (mm)																											
2.0	Spot defect 	① light dot (LCD/TP/Polarizer black/white spot, light dot, pinhole, dent, stain) <table border="1"> <thead> <tr> <th rowspan="2">Zone Size (mm)</th> <th colspan="3">Acceptable Qty</th> </tr> <tr> <th>A</th> <th>B</th> <th>C</th> </tr> </thead> <tbody> <tr> <td>$\Phi \leq 0.10$</td> <td colspan="3">Ignore</td> </tr> <tr> <td>$0.10 < \Phi \leq 0.15$</td> <td colspan="3">3 (distance $\geq 10\text{mm}$)</td> </tr> <tr> <td>$0.15 < \Phi \leq 0.2$</td> <td colspan="3">1</td> </tr> <tr> <td>$0.2 < \Phi$</td> <td colspan="3">0</td> </tr> </tbody> </table>	Zone Size (mm)	Acceptable Qty			A	B	C	$\Phi \leq 0.10$	Ignore			$0.10 < \Phi \leq 0.15$	3 (distance $\geq 10\text{mm}$)			$0.15 < \Phi \leq 0.2$	1			$0.2 < \Phi$	0						
		Zone Size (mm)		Acceptable Qty																									
			A	B	C																								
		$\Phi \leq 0.10$	Ignore																										
		$0.10 < \Phi \leq 0.15$	3 (distance $\geq 10\text{mm}$)																										
		$0.15 < \Phi \leq 0.2$	1																										
		$0.2 < \Phi$	0																										
		② Dim spot (LCD/TP/Polarizer dim dot, light leakage, dark spot) <table border="1"> <thead> <tr> <th rowspan="2">Zone Size (mm)</th> <th colspan="3">Acceptable Qty</th> </tr> <tr> <th>A</th> <th>B</th> <th>C</th> </tr> </thead> <tbody> <tr> <td>$\Phi \leq 0.1$</td> <td colspan="3">Ignore</td> </tr> <tr> <td>$0.1 < \Phi \leq 0.2$</td> <td colspan="3">2 (distance $\geq 10\text{mm}$)</td> </tr> <tr> <td>$0.2 < \Phi \leq 0.3$</td> <td colspan="3">1</td> </tr> <tr> <td>$\Phi > 0.3$</td> <td colspan="3">0</td> </tr> </tbody> </table>	Zone Size (mm)	Acceptable Qty			A	B	C	$\Phi \leq 0.1$	Ignore			$0.1 < \Phi \leq 0.2$	2 (distance $\geq 10\text{mm}$)			$0.2 < \Phi \leq 0.3$	1			$\Phi > 0.3$	0						
		Zone Size (mm)		Acceptable Qty																									
			A	B	C																								
$\Phi \leq 0.1$	Ignore																												
$0.1 < \Phi \leq 0.2$	2 (distance $\geq 10\text{mm}$)																												
$0.2 < \Phi \leq 0.3$	1																												
$\Phi > 0.3$	0																												
③ Polarizer accidented spot <table border="1"> <thead> <tr> <th rowspan="2">Zone Size (mm)</th> <th colspan="3">Acceptable Qty</th> </tr> <tr> <th>A</th> <th>B</th> <th>C</th> </tr> </thead> <tbody> <tr> <td>$\Phi \leq 0.2$</td> <td colspan="3">Ignore</td> </tr> <tr> <td>$0.2 < \Phi \leq 0.5$</td> <td colspan="3">2 (distance $\geq 10\text{mm}$)</td> </tr> <tr> <td>$\Phi > 0.5$</td> <td colspan="3">0</td> </tr> </tbody> </table>	Zone Size (mm)	Acceptable Qty			A	B	C	$\Phi \leq 0.2$	Ignore			$0.2 < \Phi \leq 0.5$	2 (distance $\geq 10\text{mm}$)			$\Phi > 0.5$	0												
Zone Size (mm)		Acceptable Qty																											
	A	B	C																										
$\Phi \leq 0.2$	Ignore																												
$0.2 < \Phi \leq 0.5$	2 (distance $\geq 10\text{mm}$)																												
$\Phi > 0.5$	0																												
Line defect (LCD/TP /Polarizer black/white line, scratch, stain)	<table border="1"> <thead> <tr> <th rowspan="2">Width(mm)</th> <th rowspan="2">Length(mm)</th> <th colspan="3">Acceptable Qty</th> </tr> <tr> <th>A</th> <th>B</th> <th>C</th> </tr> </thead> <tbody> <tr> <td>$\Phi \leq 0.03$</td> <td>Ignore</td> <td colspan="3">Ignore</td> </tr> <tr> <td>$0.03 < W \leq 0.05$</td> <td>$L \leq 3.0$</td> <td colspan="3">$N \leq 2$</td> </tr> <tr> <td>$0.05 < W \leq 0.08$</td> <td>$L \leq 2.0$</td> <td colspan="3">$N \leq 2$</td> </tr> <tr> <td>$0.08 < W$</td> <td colspan="4">Define as spot defect</td> </tr> </tbody> </table>	Width(mm)	Length(mm)	Acceptable Qty			A	B	C	$\Phi \leq 0.03$	Ignore	Ignore			$0.03 < W \leq 0.05$	$L \leq 3.0$	$N \leq 2$			$0.05 < W \leq 0.08$	$L \leq 2.0$	$N \leq 2$			$0.08 < W$	Define as spot defect			
Width(mm)	Length(mm)			Acceptable Qty																									
		A	B	C																									
$\Phi \leq 0.03$	Ignore	Ignore																											
$0.03 < W \leq 0.05$	$L \leq 3.0$	$N \leq 2$																											
$0.05 < W \leq 0.08$	$L \leq 2.0$	$N \leq 2$																											
$0.08 < W$	Define as spot defect																												

Number	Items	Criteria (mm)				
3.0	Polarizer Bubble	Zone Size (mm)	Acceptable Qty			
			A	B	C	
		$\Phi \leq 0.2$	Ignore		Ignore	
		$0.2 < \Phi \leq 0.4$	2 (distance ≥ 10 mm)			
		$0.4 < \Phi \leq 0.6$	1			
$0.6 < \Phi$	0					
4.0	SMT	According to IPC-A-610C class II standard . Function defect and missing part are major defect ,the others are minor defect.				
5.0	TP Related	TP bubble/accidented spot	Size Φ (mm)	Acceptable Qty		
				A	B	C
			$\Phi \leq 0.1$	Ignore		Ignore
			$0.1 < \Phi \leq 0.2$	2		
			$0.2 < \Phi \leq 0.3$	1		
$0.3 < \Phi$	0					
Assembly deflection	beyond the edge of backlight ≤ 0.15 mm					
Newton Ring	Newton Ring area $> 1/3$ TP area NG Newton Ring area $\leq 1/3$ TP area OK	 <p>1 规律性 2 非规律性 似牛顿环</p>				

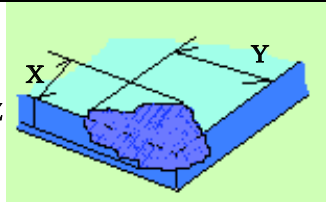
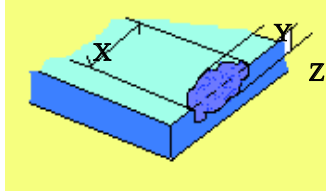
		<p>TP corner broken</p> <p>X: length</p> <p>Y: width</p> <p>Z: height</p>	<table border="1"> <thead> <tr> <th>X</th> <th>Y</th> <th>Z</th> </tr> </thead> <tbody> <tr> <td>$X \leq 3.0\text{mm}$</td> <td>$Y \leq 3.0\text{mm}$</td> <td>$Z < \text{LCD thickness}$</td> </tr> </tbody> </table> <p>* Circuitry broken is not allowed.</p>	X	Y	Z	$X \leq 3.0\text{mm}$	$Y \leq 3.0\text{mm}$	$Z < \text{LCD thickness}$	 <p>A 3D perspective diagram of a rectangular LCD panel with a blue corner broken out. The dimensions X, Y, and Z are indicated with arrows. X is the length of the broken corner along the top edge, Y is the width along the side edge, and Z is the height of the broken corner. The background is light green.</p>
X	Y	Z								
$X \leq 3.0\text{mm}$	$Y \leq 3.0\text{mm}$	$Z < \text{LCD thickness}$								
		<p>TP edge broken</p> <p>X: length</p> <p>Y: width</p> <p>Z: height</p>	<table border="1"> <thead> <tr> <th>X</th> <th>Y</th> <th>Z</th> </tr> </thead> <tbody> <tr> <td>$X \leq 6.0\text{mm}$</td> <td>$Y \leq 2.0\text{mm}$</td> <td>$Z < \text{LCD thickness}$</td> </tr> </tbody> </table> <p>* Circuitry broken is not allowed.</p>	X	Y	Z	$X \leq 6.0\text{mm}$	$Y \leq 2.0\text{mm}$	$Z < \text{LCD thickness}$	 <p>A 3D perspective diagram of a rectangular LCD panel with a blue edge broken out. The dimensions X, Y, and Z are indicated with arrows. X is the length of the broken edge along the top edge, Y is the width along the side edge, and Z is the height of the broken edge. The background is light yellow.</p>
X	Y	Z								
$X \leq 6.0\text{mm}$	$Y \leq 2.0\text{mm}$	$Z < \text{LCD thickness}$								

10. Reliability Test Items

Test Item	Test Condition	Test result
High temperature storage	80±3°C, 24H ;	Inspection after 2~4hours storage at room temperature, the sample shall be free from defects: 1. Air bubble in the LCD; 2. Non-display; 3. Glass crack; 4. The electrical characteristics requirements shall be satisfied.
Low temperature storage	-30±3°C, 24H ;	
High temperature operation	80±3°C, 24H ;	
Low temperature operation	-30±3°C, 24H ;	
High temperature / humidity	60°C±3°C, 90%±3%RH, 48H ;	
Thermal Shock	-30°C/0.5h~+80°C/0.5h for a total 24 cycles ;	
Vibration Test	Frequency 10Hz~55Hz~10Hz Amplitude : 1.5mm, X, Y, Z direction for total 1H ; (Packing condition)	
ESD test	±4KV, Human Body Mode, 150pF/330Ω ; ±8KV, Air Mode, 150pF/330Ω ;	

Remark:

1. The test samples should be applied to only one test item.
2. Sample size for each test item is 2pcs.
3. Failure Judgment Criterion: Basic Specification, Electrical Characteristic, Mechanical Characteristic, Optical Characteristic.

11. Packing Specification

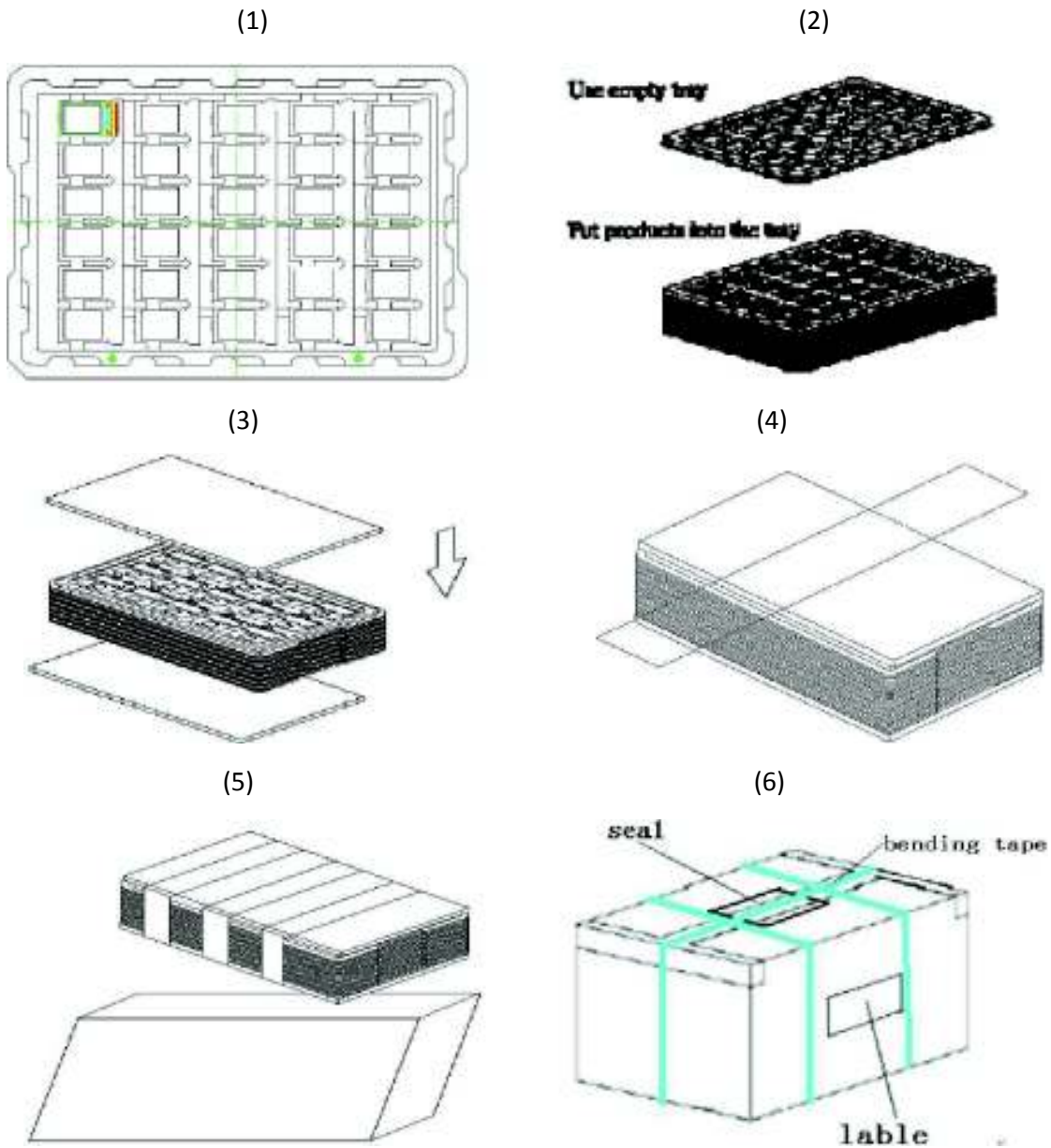

1. Put module into tray cavity.
2. Tray stacking.
3. Put 1 foam under the tray stack and 1 foam above.
4. Fix the cardboard to the tray stack with adhesive tape.
5. Put the tray stack into carton.
6. Carton sealing with adhesive tape.

12. Precautions FOR USING LCM

Suggestions for using modules

12.1 The display panel is made of glass and polarizer. As glass is fragile. It tends to become or chipped during handling especially on the edges. Please avoid dropping or jarring. Do not subject it to a mechanical shock by dropping it or impact.

12.2 If the display panel is damaged and the liquid crystal substance leaks out, be sure not to get any in your mouth. If the substance contacts your skin or clothes, wash it off using soap and water.

12.3 Do not apply excessive force to the display surface or the adjoining areas since this may cause the color tone to vary. Do not touch the display with bare hands. This will stain the display area and degraded insulation between terminals (some cosmetics are determined to the polarizer).请

12.4 The polarizer covering the display surface of the LCD module is soft and easily scratched. Handle this polarizer carefully. Do not touch, push or rub the exposed polarizers with anything harder than an HB pencil lead (glass, tweezers, etc.). Do not put or attach anything on the display area to avoid leaving marks on it. Condensation on the surface and contact with terminals due to cold will damage, stain or dirty the polarizer. After products are tested at low temperature they must be warmed up in a container before coming in to contact with room temperature air.

12.5 If the display surface becomes contaminated, breathe on the surface and gently wipe it with a soft dry cloth. If it is heavily contaminated, moisten cloth with one of the following solvents

- Isopropyl alcohol
- Ethyl alcohol

Do not scrub hard to avoid damaging the display surface.



12.6 Solvents other than those above-mentioned may damage the polarizer. Especially, do not use the following.

- Water
- Ketone
- Aromatic solvents

Wipe off saliva or water drops immediately, contact with water over a long period of time may cause deformation or color fading. Avoid contact with oil and fats.

12.7 Exercise care to minimize corrosion of the electrode. Corrosion of the electrodes is accelerated by water droplets, moisture condensation or a current flow in a high-humidity environment.

12.8 Install the LCD Module by using the mounting holes. When mounting the LCD module make sure it is free of twisting, warping and distortion. In particular, do not forcibly pull or bend the I O cable or the backlight cable.

12.9 Do not attempt to disassemble or process the LCD module.

12.10 NC terminal should be open. Do not connect anything.

12.11 If the logic circuit power is off, do not apply the input signals.

12.12 Electro-Static Discharge Control, Since this module uses a CMOS LSI, the same careful attention should be paid to electrostatic discharge as for an ordinary CMOS IC. To prevent destruction of the elements by static electricity, be careful to maintain an optimum work environment. ◦

- Before removing LCM from its packing case or incorporating it into a set, be sure the module and your body have the same electric potential. Be sure to ground the body when handling the LCD modules.
- Tools required for assembling, such as soldering irons, must be properly grounded. Make certain the AC power source for the soldering iron does not leak. When using an electric screwdriver to attach LCM, the screwdriver should be of ground potentiality to minimize as much as possible any transmission of electromagnetic waves produced sparks coming from the commutator of the motor.
- To reduce the amount of static electricity generated, do not conduct assembling and other work under dry conditions. To reduce the generation of static electricity be careful that the air in the work is not too dry. A relative humidity of 50%-60% is recommended. As far as possible make the electric potential of your work clothes and that of the work bench the ground potential.
- The LCD module is coated with a film to protect the display surface. Exercise care when peeling off this protective film since static electricity may be generated.

12.13 Since LCM has been assembled and adjusted with a high degree of precision, avoid applying excessive shocks to the module or making any alterations or modifications to it.

- Do not alter, modify or change the shape of the tab on the metal frame.
- Do not make extra holes on the printed circuit board, modify its shape or change the positions of components to be attached.
- Do not damage or modify the pattern writing on the printed circuit board.
- Absolutely do not modify the zebra rubber strip (conductive rubber) or heat seal connector.
- Except for soldering the interface, do not make any alterations or modifications with a soldering iron.

- Do not drop, bend or twist the LCM.

12.14 Handling precaution for LCM

- LCM is easy to be damaged. Please note below and be careful for handling.
- Correct handling:



As above picture, please handle with anti-static gloves around LCM edges.
 像上面的图片,请戴抗静电手套,并拿模块边缘.

- Incorrect handling:



Please don't hold the surface of IC.
 请不要拿着 IC 的表面



Please don't operate with sharp stick such as pens.
 请不要用尖锐的物体来操作, 例如用笔尖

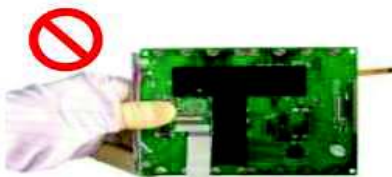

Please don't touch IC directly.
 不要直接地触摸 IC



Please don't stack LCM.
 不要把模块叠在一起

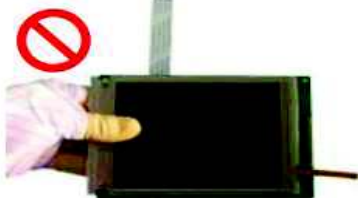

Please don't hold the surface of panel.
 请不要拿着面板的表面



Please don't stretch interface of output, such as FPC cable.
 请不要拉扯输出接口, 如接口线

12.15 Installing LCM

- Cover the surface with a transparent protective plate to protect the polarizer and LC cell.

-when assembling the LCM into other equipment, the spacer to the bit between the LCM and the fitting plate should have enough height to avoid causing stress to the module surface, refer to the individual specifications for measurements. The measurement tolerance should be +/-0.1mm.

12.16 Precaution for the module with BTB connector:

-please note the position of the male and female connector position, don't assemble or assemble like the method which the following picture shows:

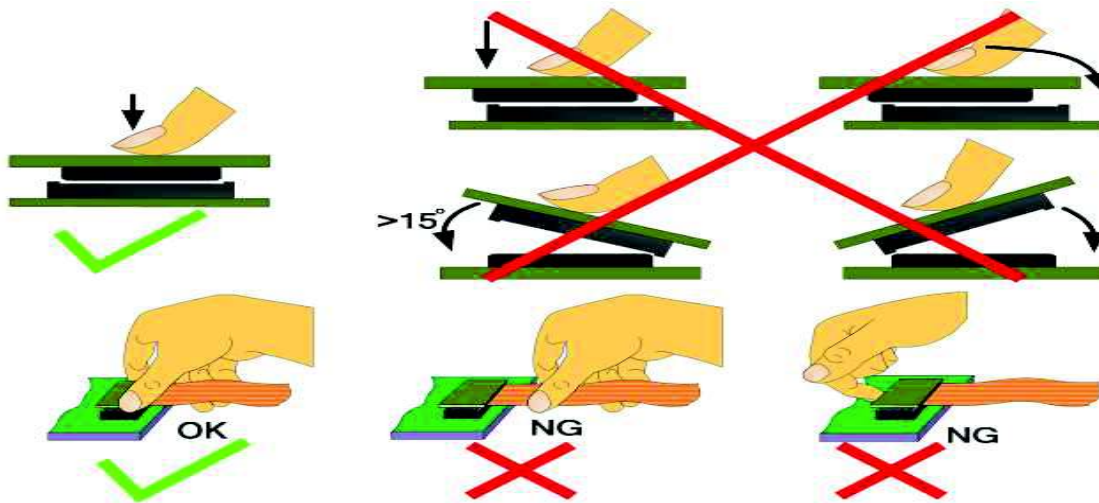

12.17 Precaution for soldering the LCM :

	Manual soldering 手工焊接	Machine drag soldering 机器拖焊	Machine press soldering 机器压焊
No RoHS Product 非环保产品	290°C ~350°C. Time : 3-5S.	330°C ~350°C. Speed : 4-8 mm/s.	300°C ~330°C. Time : 3-6S. Press: 0.8~1.2Mpa
RoHS Product 环保产品	340°C ~370°C. Time : 3-5S.	350°C ~370°C. Time : 4-8 mm/s.	330°C ~360°C. Time : 3-6S. Press: 0.8~1.2Mpa

-If soldering flux is used, be sure to remove any remaining flux after finishing to soldering operation (This does not apply in the case of a non-halogen type of flux). It is recommended that you protect the LCD surface with a cover during soldering to prevent any damage due to flux spatters.

-When soldering the electroluminescent panel and PC board, the panel and board should not be detached more than three times. This maximum number is determined by the temperature and time conditions mentioned above, though there may be some variance depending on the temperature of the soldering iron.



-When remove the electroluminescent panel from the PC board, be sure the solder has completely melted, the soldered pad on the PC board could be damaged.

12.18 Precautions for Operation :

-Viewing angle varies with the change of liquid crystal driving voltage (VLCD). Adjust VLCD to show the best contrast.

-It is an indispensable condition to drive LCD's within the specified voltage limit since the higher voltage than the limit cause the shorter LCD life. An electrochemical reaction due to direct current causes LCD's undesirable deterioration, so that the use of direct current drive should be avoided.

-Response time will be extremely delayed at lower temperature than the operating temperature range and on the other hand at higher temperature LCD's show dark color in them. However those phenomena do not mean malfunction or out of order with LCD's, which will come back in the specified operating temperature.

-If the display area is pushed hard during operation, the display will become abnormal. However, it will return to normal if it is turned off and then back on.

-A slight dew depositing on terminals is a cause for electro-chemical reaction resulting in terminal open circuit. Usage under the maximum operating temperature, 50%RH or less is required.

-Input logic voltage before apply analog high voltage such as LCD driving voltage when power on. Remove analog high voltage before logic voltage when power off the module. Input each signal after the positive/negative voltage becomes stable.

-Please keep the temperature within the specified range for use and storage. Polarization degradation, bubble generation or polarizer peel-off may occur with high temperature and high humidity. .

12.19 Safety

-It is recommended to crush damaged or unnecessary LCDs into pieces and wash them off with solvents such as acetone and ethanol, which should later be burned.



-If any liquid leaks out of a damaged glass cell and comes in contact with the hands, wash off thoroughly with soap and water.

-No warranty can be granted if the precautions stated above have been disregarded. The typical examples of violations are :

-Broken LCD glass.

-PCB/FPC is damaged or modified.

Storage Method

1. Store in an ambient temperature of $23^{\circ}\text{C}\pm 5^{\circ}\text{C}$, and in a relative humidity of $55\%\pm 15\%$. Don't exceed 12 months and expose to sunlight or fluorescent light.
2. Store in a clean environment, free from dust, active gas, and solvent.
3. Store in antistatic container.

Initial code

If you need this code please contact us!