



ALL SHORE INDUSTRIES, INC.

**SPECIFICATION FOR
LIQUID CRYSTAL DISPLAY MODULE**

MODULE #: ASI-_-204AAS-LJ-_YD/W



MODEL NO : ASI_-204AAS-LJ-_YD/W

RECORD OF REVISION

DATE	PAGE	SUMMARY
2003/12/19	3/10	Add the backlight color WHITE,BLUE,PURE GREEN
	5/10	5.Modify the electrical absolute maximum ratings : ARRAY LED= 5.0V→ 6.0V EDGE LED= 6.0V→ 5.0V



MODEL NO : ASI_-204AAS-LJ-_YD/W

LCD MODULE PART NUMBERING SYSTEM

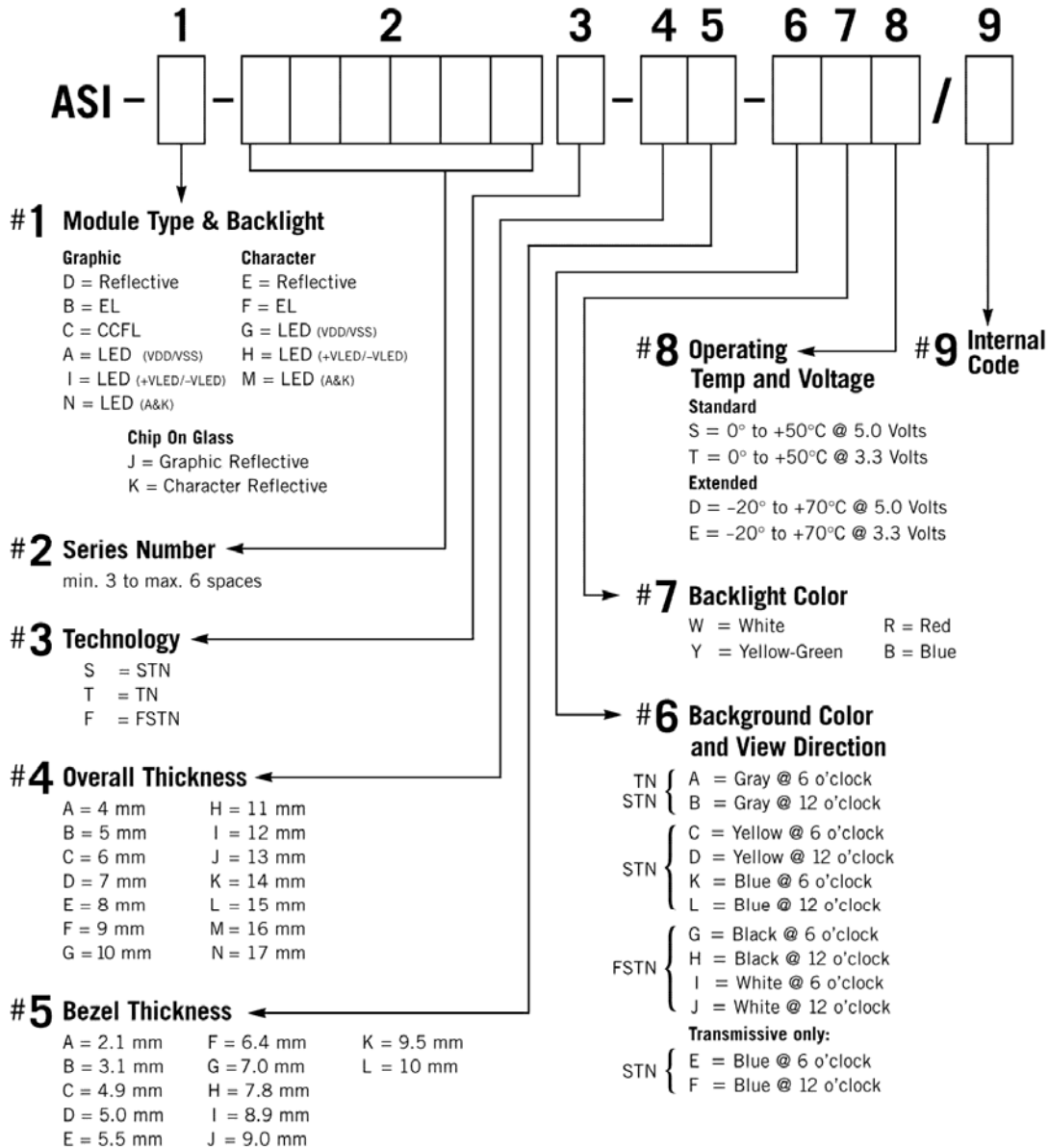

NOTE: Some options may not be available in specific modules. Please contact your Sales Representative to check availability.



MODEL NO : ASI_-204AAS-LJ-_YD/W

Absolute maximum ratings

Electrical absolute maximum ratings

<i>I T E M</i>	<i>SYMBOL</i>	<i>MIN.</i>	<i>MAX.</i>	<i>UNIT</i>	<i>COMMENT</i>
POWER SUPPLY FOR LOGIC	V _{DD} -V _{SS}	0	6.0	V	-----
INPUT VOLTAGE	V _I	V _{SS}	V _{DD}	V	-----
STATIC ELECTRICITY	-----	-----	100	V	NOTE(1)
POWER SUPPLY FOR B.L	NOTE(2)	-----	NOTE(2)	NOTE(2)	NOTE(2)

NOTE (1): ELECTRO-STATIC DISCHARGE RESISTANCE IS TESTED BY CHARGING A 200PF CAPACITOR AND DISCHARGING IT BY CONTACT WITH A INTERFACE CONNECTOR PIN.

NOTE (2):

<i>B.L TYPE</i>	<i>SYMBOL</i>	<i>MAX.</i>	<i>UNIT</i>	<i>COMMENT</i>
ARRAY LED	V _{LED}	6.0	V	YELLOW-GREEN,AMBER,ORANGE,RED
EDGE LED	V _{LED}	5.0	V	BLUE,PURE GREEN,WHITE
EL	VEL	AC115V	V	f _{EL} : 1.0KHz 60SEC.MAX
	f _{EL}	2.0	KHz	AC115V _{rms} 60SEC.MAX

Environmental absolute maximum ratings

<i>I T E M</i>	<i>CONDITION</i>	<i>OPERATION</i>		<i>STORAGE</i>		<i>COMMENT</i>
		<i>MIN.</i>	<i>MAX.</i>	<i>MIN.</i>	<i>MAX.</i>	
AMBIENT TEMPERATURE	NORMAL	0°C	50°C	-20°C	70°C	-----
	WIDE	-20°C	70°C			
HUMIDITY	-----	NOTE (3)		NOTE (3)		NO CONDENSATION
VIBRATION NOTE (3)	-----	-----	0.5G	-----	2G	10~300Hz XYZ DIRECTIONS 1 Hr EACH
SHOCK NOTE (4)	-----	-----	3G	-----	50G	10 msec XYZ DIRECTIONS 1 TIME EACH
CORROSIVE GAS	-----	NOT ACCEPTABLE		NOT ACCEPTABLE		-----

NOTE (3): T_a ≤ 50°C: 90% RH MAX.

T_a > 50°C: ABSOLUTE HUMIDITY MUST BE LOWER THAN THE HUMIDITY OF 90% RH AT 50°C. (80%RH AT 60°C)

NOTE(4): 1G=9.8m/s²

MODEL NO : ASI_-204AAS-LJ-_YD/W
Electrical characteristics
 $T_a = 25^\circ\text{C}$ $V_{DD} = 5.0 \pm 0.25\text{ V}$

<i>I T E M</i>	<i>SYMBOL</i>	<i>CONDITION</i>	<i>MIN.</i>	<i>TYP.</i>	<i>MAX.</i>	<i>UNIT</i>		
INPUT VOLTAGE	V _{IH}	-----	2.2	-----	-----	V		
	V _{IL}	-----	-----	-----	0.6	V		
OUTPUT VOLTAGE	V _{OH}	-I _{OH} = 0.2 mA	2.4	-----	-----	V		
	V _{OL}	I _{OL} = 1.2 Ma	-----	-----	0.4	V		
POWER SUPPLY CURRENT	I _{DD}	V _{DD} = 5.0V	-----	2.0	3.5	mA		
RECOMMENDED LCD DRIVING VOLTAGE, NOTE(1)	V _{DD} -V _O	STN/ FSTN DUTY =1/16 Φ=10° NOTE(2)	T _a =-20°C	-----	4.8	-----	V	
			T _a = 0°C	-----	4.7	-----	V	
			T _a = 25°C	-----	4.5	-----	V	
			T _a = 50°C	-----	4.3	-----	V	
			T _a = 70°C	-----	4.2	-----	V	
		TN DUTY =1/16 Φ=25° NOTE(2)	T _a =-20°C	-----	4.5	-----	-----	V
			T _a = 0°C	-----	4.4	-----	-----	V
			T _a = 25°C	-----	4.2	-----	-----	V
			T _a = 50°C	-----	4.0	-----	-----	V
			T _a = 70°C	-----	3.9	-----	-----	V
POWER SUPPLY CURRENT FOR B.L	NOTE(3)	NOTE(3)	-----	NOTE(3)	NOTE(3)	NOTE(3)		

NOTE (1): RECOMMENDED LCD DRIVING VOLTAGE MAY FLUCTUATE ABOUT ±0.5V BY EACH MODULE.

(2): θ = 0° : VIEWING DIRECTION AT 6 O'CLOCK
θ = 180° : VIEWING DIRECTION AT 12 O'CLOCK

(3): LED CURRENT OF DIFFERENT BACKLIGHT TYPE

<i>B.L TYPE</i>	<i>SYMBOL</i>	<i>CONDITION</i>	<i>MIN.</i>	<i>TYP.</i>	<i>MAX.</i>	<i>UNIT.</i>	<i>LED COLOR</i>
ARRAY LED	I _{LED}	V _{LED} = 5.0V	-----	150	200	mA	YELLOW-GREEN, AMBER, ORANGE, RED
EDGE LED	I _{LED}	V _{LED} = 4.0V	-----	60	80	mA	BLUE, WHITE, PURE GREEN
EL	I _{EL}	V _{EL} = AC115V f _{EL} = 400Hz	-----	230	350	mA	-----



MODEL NO : ASI_-204AAS-LJ-_YD/W

Optical characteristics

TN TYPE LCD

 $T_a = 25\text{ }^\circ\text{C}$ $V_{DD}-V_O = 4.2V$

ITEM	SYMBOL	CONDITION	MIN.	TYP	MAX.	UNIT	NOTE
VIEWING ANGLE	Φ 2- Φ 1	K = 1.4 NOTE(1)	20	30	----	deg.	NOTE(2)
CONTRAST RATIO	K	$\Phi = 25^\circ$ NOTE(1)	2.0	3.0	----	----	NOTE(2)
RESPONSE TIME	tr (rise)	$\Phi = 25^\circ$ NOTE(1)	----	150	250	ms	NOTE(2)
	tf (fall)	$\Phi = 25^\circ$ NOTE(1)	----	150	250	ms	NOTE(2)

STN TYPE LCD

 $T_a = 25\text{ }^\circ\text{C}$ $V_{DD}-V_O = 4.5V$

ITEM	SYMBOL	CONDITION	MIN.	TYP	MAX.	UNIT	NOTE
VIEWING ANGLE	Φ 2- Φ 1	K = 2.0 NOTE(1)	30	40	----	deg.	NOTE(2)
CONTRAST RATIO	K	$\Phi = 10^\circ$ NOTE(1)	3.0	4.0	----	----	NOTE(2)
RESPONSE TIME	tr (rise)	$\Phi = 10^\circ$ NOTE(1)	----	200	350	ms	NOTE(2)
	tf (fall)	$\Phi = 10^\circ$ NOTE(1)	----	300	400	ms	NOTE(2)

FSTN TYPE LCD

 $T_a = 25\text{ }^\circ\text{C}$ $V_{DD}-V_O = 4.5V$

ITEM	SYMBOL	CONDITION	MIN.	TYP	MAX.	UNIT	NOTE
VIEWING ANGLE	Φ 2- Φ 1	K = 2.0 NOTE(1)	30	40	----	deg.	NOTE(2)
CONTRAST RATIO	K	$\Phi = 10^\circ$ NOTE(1)	4.0	5.0	----	----	NOTE(2)
RESPONSE TIME	tr (rise)	$\Phi = 10^\circ$ NOTE(1)	----	200	350	ms	NOTE(2)
	tf (fall)	$\Phi = 10^\circ$ NOTE(1)	----	300	400	ms	NOTE(2)

Brightness for backlight

SYMBOL	CONDITION	MIN.	TYP.	MAX.	UNIT	B.L TYPE	NOTE
B	$\Phi = 0^\circ$	4.0	----	----	cd/m ²	EL	NOTE(2)
	$\theta = 0^\circ$	5.0	----	----		LED	NOTE(3)

NOTE (1): $\theta = 0^\circ$: VIEWING DIRECTION AT 6 O'CLOCK

$\theta = 180^\circ$: VIEWING DIRECTION AT 12 O'CLOCK

NOTE (2):SEE CUSTOMER ACCEPTANCE STANDARD SPECIFICATION FOR DEFINITION OF OPTICAL CHARACTERISTICS.

NOTE (3):UNDER NORMAL TEMPERATURE AND HUMIDITY IN A DARK ROOM.

MODEL NO : ASI_-204AAS-LJ-_YD/W

Outline dimension

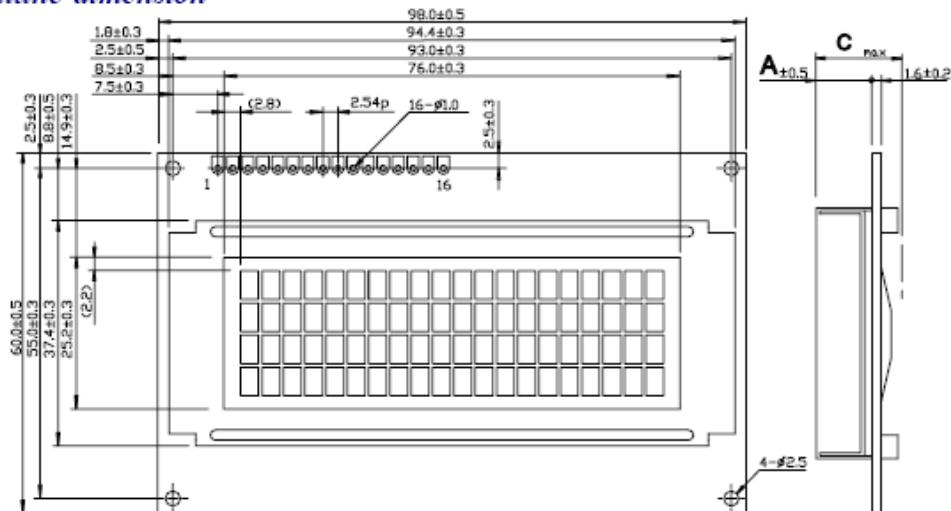

TYPE	A	C
LED B.L	9.0	15.0
EL & NO B.L	5.1	10.0

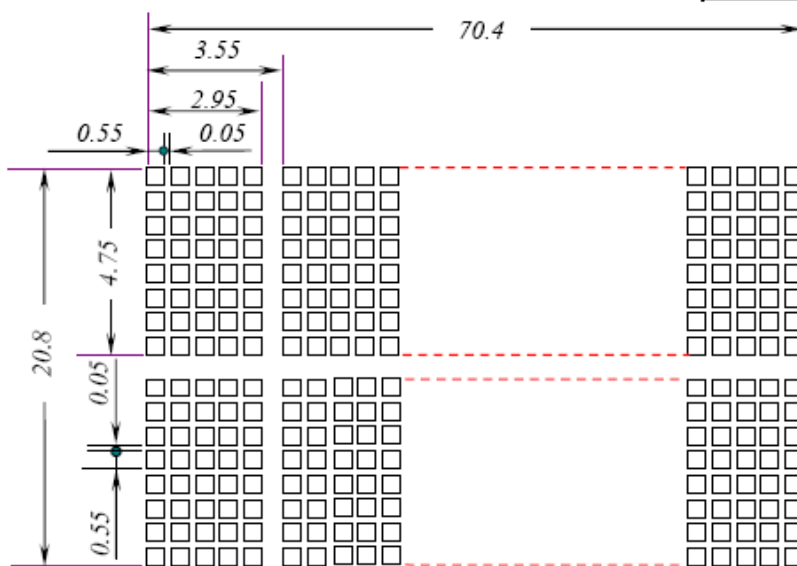

NOTE :
 1. UNIT : mm
 2. SCALE : NTS

Interface pin connection

PIN NO.	1	2	3	4	5	6	7	8
SYMBOL	V _{SS}	V _{DD}	V ₀	RS	R/W	E	DB0	DB1
PIN NO.	9	10	11	12	13	14	15	16
SYMBOL	DB2	DB3	DB4	DB5	DB6	DB7	A(+)	K(-)



MODEL NO : ASI_-204AAS-LJ-_YD/W

Block diagram

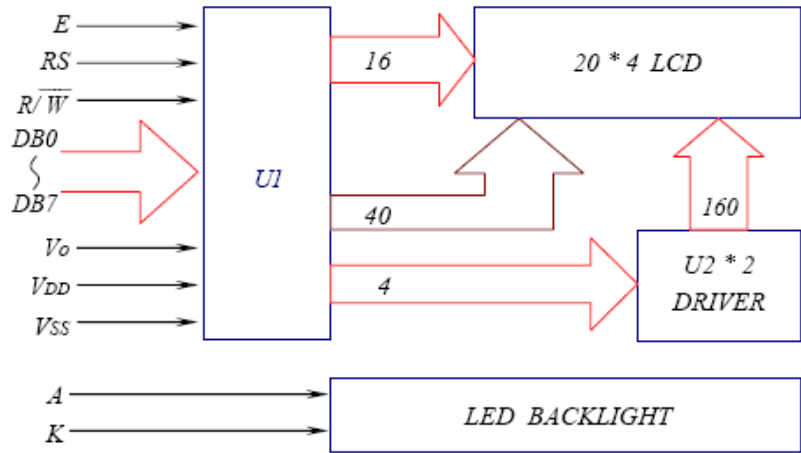

Display data address charts

Character	1	2	3	4	5	6	7	8	9	10	11	12	13	14	15	16	17	18	19	20
LINE 1	00	01	02	03	04	05	06	07	08	09	0A	0B	0C	0D	0E	0F	10	11	12	13
LINE 2	40	41	42	43	44	45	46	47	48	49	4A	4B	4C	4D	4E	4F	50	51	52	53
LINE 3	14	15	16	17	18	19	1A	1B	1C	1D	1E	1F	20	21	22	23	24	25	26	27
LINE 4	54	55	56	57	58	59	5A	5B	5C	5D	5E	5F	60	61	62	63	64	65	66	67

Power supply for LCM

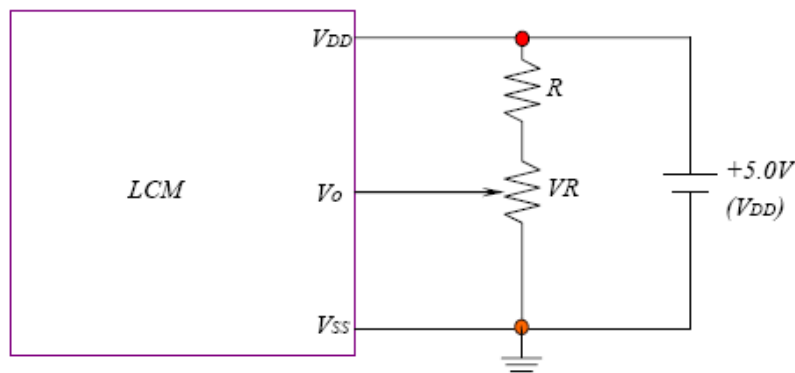

RECOMMENDED RESISTOR R: $V_{DD}-V_o \geq 1.5V$

$V_{DD}-V_o$: LCD DRIVING VOLTAGE

VR: 10KΩ ~20KΩ

MODEL NO : ASI_-204AAS-LJ-_YD/W

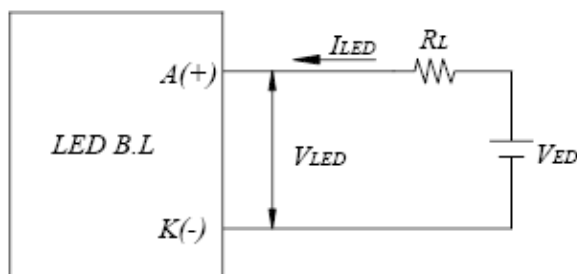
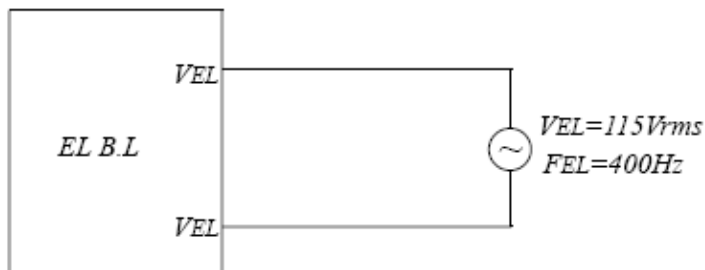
Power supply for backlight

<i>ITEM</i>	<i>LED TYPE</i>	<i>CONDITION</i>
Limit resistor of LED (R _L)	ARRAY LED	$R_L \geq ((V_{ED}-5.0V) / I_{LED})$, $I_{LED} \leq 200mA$
	EDGE LED	$R_L \geq ((V_{ED}-4.0V) / I_{LED})$, $I_{LED} \leq 80mA$

The information presented in this datasheet has been carefully checked and is believed to be accurate; however, no responsibility is assumed for inaccuracies. Information contained herein is for selection purposes only, and is subject to change without notice. Please contact ASI for current datasheets prior to designing.