



ALL SHORE INDUSTRIES, INC.

SPECIFICATION FOR LIQUID CRYSTAL DISPLAY MODULE

MODULE #: ASI-D-2406BS-GC-_S/W

- (1) NUMBER OF DOT----- 240 W* 64 H DOTS
- (2) MODULE SIZE----- 125.0 W * 60.0 H * "C" T (Max) mm
- (3) EFFECTIVE AREA----- 111.6 W * 37.0 H mm
- (4) ACTIVE AREA----- 105.57 W * 31.97 H mm
- (5) DOT SIZE ----- 0.41 W * 0.47 H mm
- (6) DOT PITCH----- 0.44 W * 0.50 H mm



MODEL NO : ASI-D-2406BS-GC-_S/W

RECORDS OF REVISION		DOC . FIRST ISSUE May, 2003
DATE	REVISED DRAWING NO.	SUMMARY



MODEL NO : ASI-D-2406BS-GC-_S/W

LCD MODULE PART NUMBERING SYSTEM

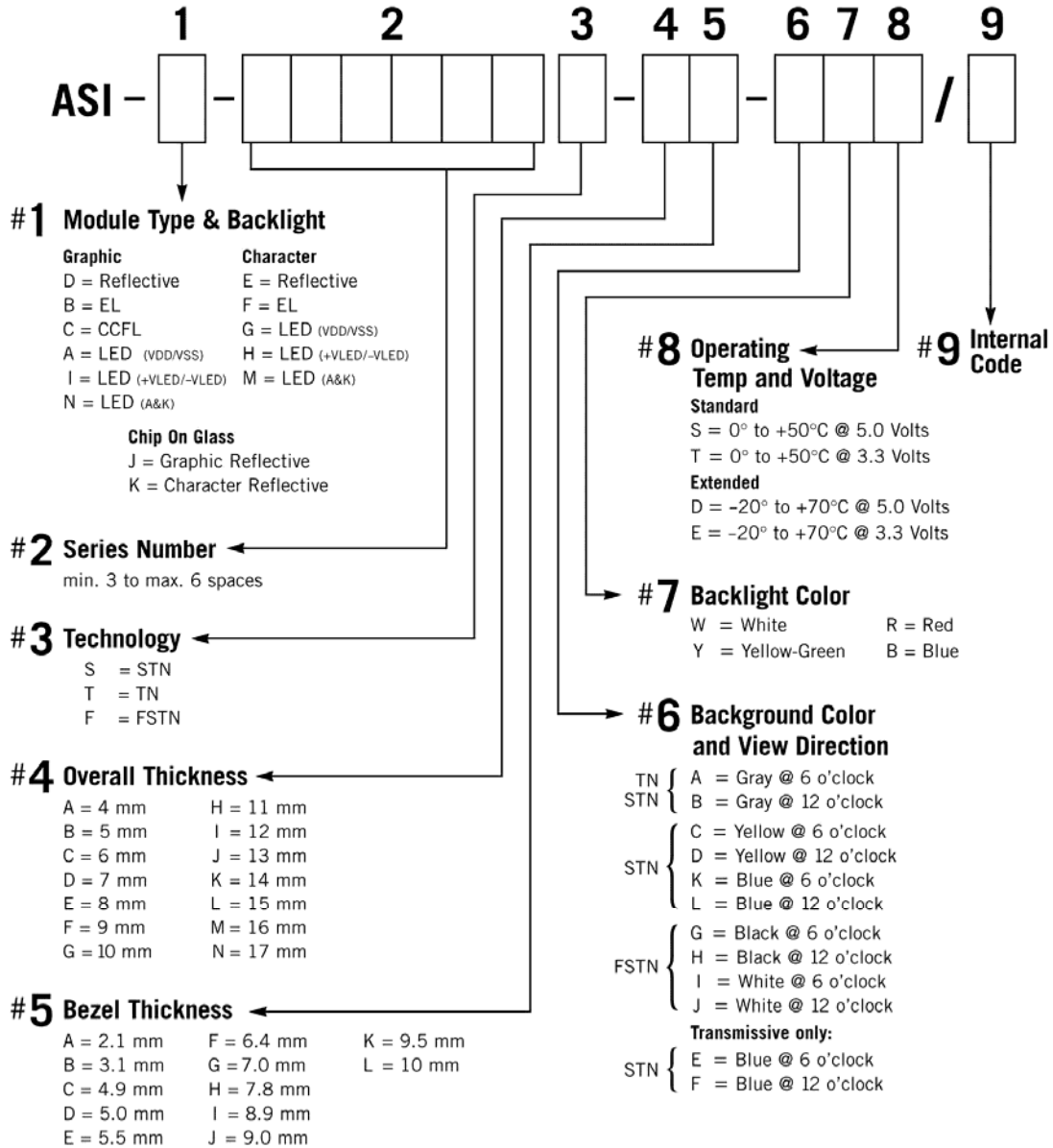

NOTE: Some options may not be available in specific modules. Please contact your Sales Representative to check availability.



MODEL NO : ASI-D-2406BS-GC-_S/W

1. GENERAL SPECIFICATIONS

1.1 GENERAL SPECIFICATIONS

PLEASE REFER TO :

"CUSTOMER ACCEPTANCE STANDARD SPECIFICATIONS :

1.2 APPLICATION NOTES FOR CONTROLLER / DRIVER :

PLEASE REFER TO :

CUSTOMER ACCEPTANCE STANDARD SPECIFICATIONS :

1.3 THIS INDIVIDUAL SPECIFICATIONS IS PRIOR TO GENERAL SPECIFICATIONS .

2. MECHANICAL SPECIFICATIONS

- (1) NUMBER OF DOT----- 240 W* 64 H DOTS
- (2) MODULE SIZE----- 125.0 W * 60.0 H * "C" T (Max) mm
- (3) EFFECTIVE AREA----- 111.6 W * 37.0 H mm
- (4) ACTIVE AREA----- 105.57 W * 31.97 H mm
- (5) DOT SIZE ----- 0.41 W * 0.47 H mm
- (6) DOT PITCH----- 0.44 W * 0.50 H mm



MODEL NO : ASI-D-2406BS-GC-_S/W

3. ABSOLUTE MAXIMUM RATINGS

3.1 ELECTRICAL ABSOLUTE MAXIMUM RATINGS.

<i>I T E M</i>	<i>SYMBOL</i>	<i>MIN.</i>	<i>MAX.</i>	<i>UNIT</i>	<i>COMMENT</i>
POWER SUPPLY FOR LOGIC	V _{DD} -V _{SS}	0	6.0	V	-----
INPUT VOLTAGE	V _I	V _{SS}	V _{DD}	V	-----
STATIC ELECTRICITY	-----	-----	100	V	NOTE (1)
POWER SUPPLY FOR EL BACKLIGHT	V _{EL}	-----	AC200	V _{rms}	f _{EL} =1.0KHz 60 SEC.MAX
	f _{EL}	-----	2.0	KHz	AC115 V _{rms} 60 SEC.MAX
POWER SUPPLY FOR LED	V _{LED}	-----	5.0	V	-----

NOTE (1): ELECTRO-STATIC DISCHARGE RESISTANCE IS TESTED BY CHARGING A 200PF CAPACITOR AND DISCHARGING IT BY CONTACT WITH A INTERFACE CONNECTOR PIN.

3.3 ENVIRONMENTAL ABSOLUTE MAXIMUM RATINGS .

<i>I T E M</i>	<i>OPERATING</i>		<i>STORAGE</i>		<i>COMMENT</i>
	<i>MIN.</i>	<i>MAX.</i>	<i>MIN.</i>	<i>MAX.</i>	
AMBIENT TEMPERATURE	-20°C	70°C	-20°C	70°C	-----
HUMIDITY	NOTE (2)		NOTE (2)		NO CONDENSATION
VIBRATION NOTE (3)	-----	0.5G	-----	2G	10~300HZ XYZ DIRECTIONS 1 Hr EACH
SHOCK NOTE (3)	-----	3G	-----	50G	10 msec XYZ DIRECTIONS 1 TIME EACH
CORROSIVE GAS	NOT ACCEPTABLE		NOT ACCEPTABLE		-----

NOTE (2): T_a ≤ 50°C: 90% RH MAX.

T_a > 50°C: ABSOLUTE HUMIDITY MUST BE LOWER THAN THE HUMIDITY OF 90% RH AT 50°C. (80%RH AT 60°C)

NOTE (3): 1G = 9.8 m/s²



MODEL NO : ASI-D-2406BS-GC-_S/W

4. ELECTRICAL CHARACTERISTICS

<i>I T E M</i>	<i>SYMBOL</i>	<i>CONDITION</i>	<i>MIN.</i>	<i>TYP.</i>	<i>MAX.</i>	<i>UNIT</i>	
POWER SUPPLY VOLTAGE FOR CIRCUIT	$V_{DD}-V_{SS}$	-----	4.75	5.0	5.25	V	
INPUT VOLTAGE	V_{IH}	H LEVEL	2.0	-----	V_{DD}	V	
	V_{IL}	L LEVEL	0	-----	0.8	V	
OUTPUT VOLTAGE	V_{OH}	$I_{OH} = -0.3 \text{ mA}$	2.4	-----	-----	V	
	V_{OL}	$I_{OH} = 3.0 \text{ mA}$	-----	-----	0.4	V	
POWER SUPPLY CURRENT	I_{DD}	$V_{DD}-V_{SS} = 5.0 \text{ V}$	-----	10.0	20.0	mA	
RECOMMENDED LCD DRIVING VOLTAGE, NOTE(1)	$V_{DD}-V_{O}$	STN/ FSTN DUTY =1/64 $\Phi=10^\circ$ NOTE(2)	$T_a=-20^\circ\text{C}$	-----	8.9	-----	V
		$T_a=25^\circ\text{C}$	-----	8.5	-----	V	
		$T_a=70^\circ\text{C}$	-----	8.1	-----	V	
POWER SUPPLY CURRENT FOR EL BACKLIGHT	I_{EL}	$V_{EL} = 115V_{rms}$ $f_{EL} = 400\text{Hz}$	-----	8.0	-----	mArms	
POWER SUPPLY CURRENT FOR LED	I_{LED}	NOTE(3)	-----	NOTE(3)	NOTE(3)	mA	

NOTE (1): RECOMMENDED LCD DRIVING VOLTAGE MAY FLUCTUATE ABOUT $\pm 0.5\text{V}$ BY EACH MODULE.

(2): $\theta = 0^\circ$: VIEWING DIRECTION AT 6 O'CLOCK

$\theta = 180^\circ$: VIEWING DIRECTION AT 12 O'CLOCK

(3): LED CURRENT FOR DIFFERENT LED BACKLIGHT TYPE

<i>LED B.L TYPE</i>	<i>CONDITION</i>	<i>I_{LED}</i>				<i>LED COLOR</i>
		<i>MIN.</i>	<i>TYP.</i>	<i>MAX.</i>	<i>UNIT.</i>	
LED B.L (ARRAY)	$V_{DD} = 5.0\text{V}$	-----	280	420	mA	YELLOW-GREEN、RED AMBER、ORANGE
LED B.L (EDGE)	$V_{LED} = 4.0\text{V}$	-----	75	100	mA	BLUE、WHITE PURE-GREEN



MODEL NO : ASI-D-2406BS-GC-_S/W

5. OPTICAL CHARACTERISTICS.

$T_a = 25^{\circ}\text{C}$ $V_{DD} = 5.0\text{ V}$

STN TYPE LCD

$T_a = 25^{\circ}\text{C}$ $V_{DD}-V_O = 8.5\text{ V}$

ITEM	SYMBOL	CONDITION	MIN.	TYP.	MAX.	UNIT	NOTE
VIEWING ANGLE	$\Phi 2-\Phi 1$	$K = 2.0$ NOTE(1)	30	40	----	deg.	NOTE(2)
CONTRAST RATIO	K	$\Phi = 10^{\circ}$ NOTE(1)	3.0	4.0	----	----	NOTE(2)
RESPONSE TIME	tr (rise)	$\Phi = 10^{\circ}$ NOTE(1)	----	200	350	ms	NOTE(2)
	tf (fall)	$\Phi = 10^{\circ}$ NOTE(1)	----	300	400	ms	NOTE(2)

FSTN、STN BLUE TYPE LCD

$T_a = 25^{\circ}\text{C}$ $V_{DD}-V_O = 8.5\text{ V}$

ITEM	SYMBOL	CONDITION	MIN.	TYP.	MAX.	UNIT	NOTE
VIEWING ANGLE	$\Phi 2-\Phi 1$	$K = 2.0$ NOTE(1)	30	40	----	deg.	NOTE(2)
CONTRAST RATIO	K	$\Phi = 10^{\circ}$ NOTE(1)	4.0	5.0	----	----	NOTE(2)
RESPONSE TIME	tr (rise)	$\Phi = 10^{\circ}$ NOTE(1)	----	200	350	ms	NOTE(2)
	tf (fall)	$\Phi = 10^{\circ}$ NOTE(1)	----	300	400	ms	NOTE(2)

Brightness for LCM backlight

SYMBOL	CONDITION	MIN.	TYP.	MAX.	UNIT	LED TYPE	NOTE
B	$\Phi = 0^{\circ}$ $\theta = 0^{\circ}$	4.0	----	----	cd/m ²	EL BACKLIGHT	NOTE(2) NOTE(3)
		5.0	----	----		YELLOW-GREEN、RED AMBER、ORANGE	
		6.0	----	----		BLUE、WHITE、 PURE-GREEN	

NOTE (1): $\theta = 0^{\circ}$: VIEWING DIRECTION AT 6 O'CLOCK

$\theta = 180^{\circ}$: VIEWING DIRECTION AT 12 O'CLOCK

NOTE (2): SEE CUSTOMER ACCEPTANCE STANDARD SPECIFICATION FOR DEFINITION OF OPTICAL CHARACTERISTICS.

NOTE (3): UNDER NORMAL TEMPERATURE AND HUMIDITY IN A DARK ROOM.

MODEL NO : ASI-D-2406BS-GC-_S/W

6. OUTLINE DIMENSION

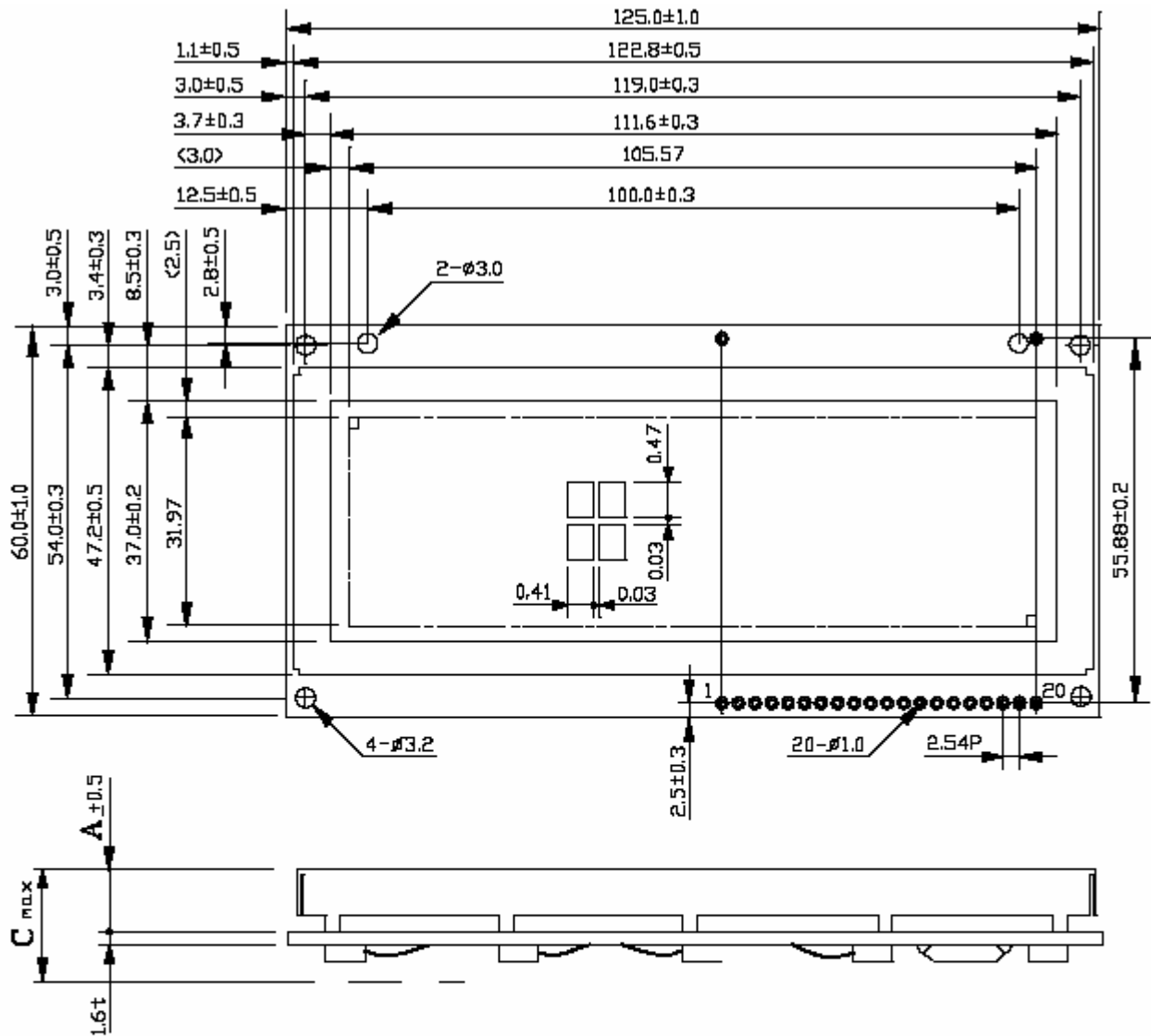

TYPE	A	C
LED B.L	9.5	15.0
EL & NO B.L	4.5	10.0

NOTE :

1.UNIT : mm

2.SCALE : NTS



MODEL NO : ASI-D-2406BS-GC-_S/W

Interface pin connection

PIN NO.	SYMBOL	FUNCTION
1	V _{SS}	POWER SUPPLY (GND)
2	V _{DD}	POWER SUPPLY (+5V)
3	V _O	OPERATING VOLTAGE FOR LCD DRIVING
4	C/ \bar{D}	$\bar{WR}="L", C/\bar{D}="H"$: COMMAND WRITE C/ $\bar{D}="L"$: DATA WRITE $\bar{RD}="L", C / \bar{D}="H"$: STATUS READ C/ $\bar{D}="L"$: DATA READ
5	\bar{RD}	L: DATA READ (LCD MODULE → MPU)
6	\bar{WR}	L: DATA WRITE (LCD MODULE ← MPU)
7	DB0	DATA INPUT/OUTPUT (LSB)
8	DB1	DATA INPUT/OUTPUT
9	DB2	DATA INPUT/OUTPUT
10	DB3	DATA INPUT/OUTPUT
11	DB4	DATA INPUT/OUTPUT
12	DB5	DATA INPUT/OUTPUT
13	DB6	DATA INPUT/OUTPUT
14	DB7	DATA INPUT/OUTPUT (MSB)
15	\bar{CE}	L: CHIP ENABLE
16	\bar{RES}	L: RESET
17	V _{EE}	POWER SUPPLY FOR LCD DRIVING OUTPUT
18	LC	H: LED BACKLIGHT LIGHT ON
19	LK	POWER SUPPLY FOR LED BACKLIGHT (-)
20	LA	POWER SUPPLY FOR LED BACKLIGHT (+)

MODEL NO : ASI-D-2406BS-GC-_S/W

8. DETAIL DRAWING OF DOT MATRIX

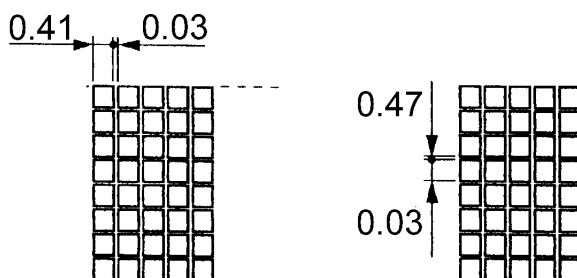

9. BLOCK DIAGRAM

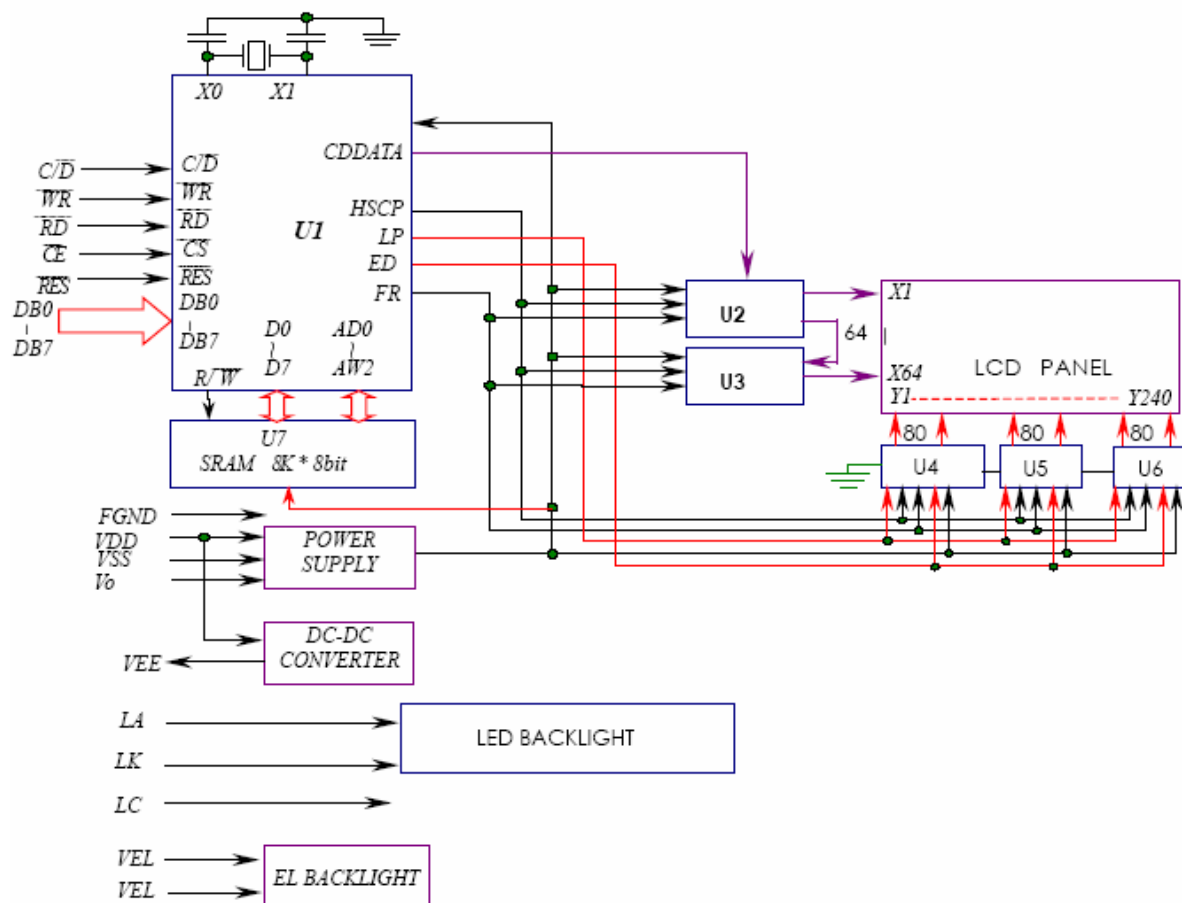

MODEL NO : ASI-D-2406BS-GC-_S/W

10. POWER SUPPLY

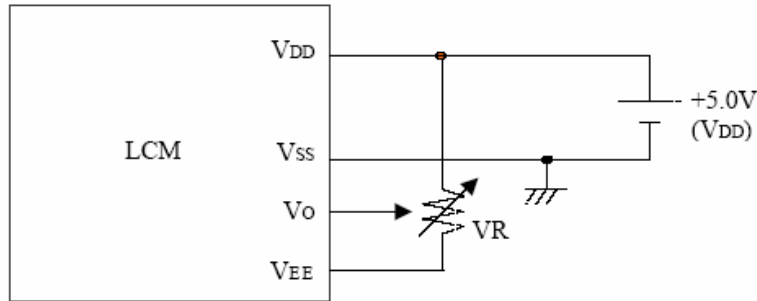

V_{DD}-V_o: LCD DRIVING VOLTAGE
 VR: 200KΩ

10.1 Power supply for backlight

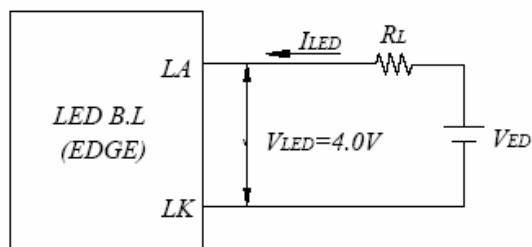
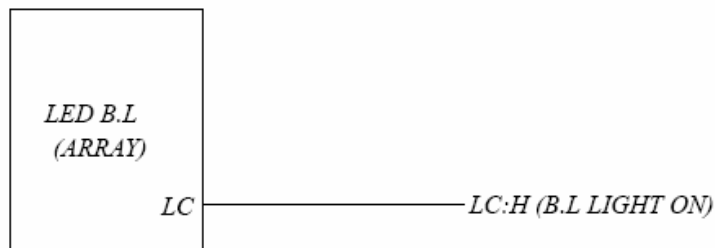
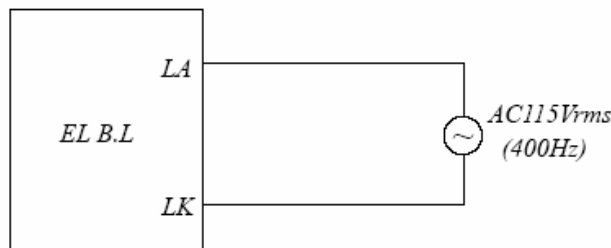

$$R_L \geq (V_{ED} - V_{LED}) / I_{LED}, I_{LED} \leq 100.0 \text{ mA (max)}$$